

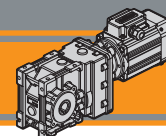

Motoriduttori ad assi ortogonali
Helical bevel gearmotors





Indice	Index	Pag. Page
Caratteristiche tecniche	<i>Technical features</i>	C2
Designazione	<i>Classification</i>	C2
Sensi di rotazione	<i>Direction of rotation</i>	C3
Simbologia	<i>Symbols</i>	C3
Lubrificazione	<i>Lubrication</i>	C4
Carichi radiali	<i>Radial loads</i>	C4
Motori applicabili	<i>Motors adapters</i>	C4
Dati tecnici	<i>Technical data</i>	C5
Dimensioni	<i>Dimensions</i>	C13
Accessori	<i>Accessories</i>	C17

Questa sezione annulla e sostituisce ogni precedente edizione o revisione. Qualora questa sezione non Vi sia giunta in distribuzione controllata, l'aggiornamento dei dati ivi contenuto non è assicurato. **In tal caso la versione più aggiornata è disponibile sul nostro sito internet www.transtecno.com**

*This section replaces any previous edition and revision. If you obtained this catalogue other than through controlled distribution channels, the most up to date content is not guaranteed. **In this case the latest version is available on our web site www.transtecno.com***

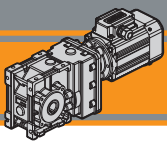

CMB Motoriduttori ad assi ortogonali Helical bevel gearmotors

Caratteristiche tecniche

I motoriduttori ad assi ortogonali della serie CMB sono caratterizzati da un elevato grado di modularità: sono stati realizzati con una carcassa completamente intercambiabile con quella dei riduttori a vite senza fine della serie CM.

Sono pertanto configurabili secondo le esigenze dell'applicazione con flangia di uscita, albero di uscita, braccio di reazione.

Caratteristiche comuni a tutta la serie:

- Carcassa in alluminio.
- Ingranaggi cilindrici a denti elicoidali, induriti e rettificati.
- Lubrificazione permanente con olio sintetico.
- Disponibili con giunto elastico in ingresso

The high degree of modularity of CMB helical bevel gearmotors allows it to be completely interchangeable with CM wormgearboxes.

It is possible to set up the version required using output flanges, output shafts and optional torque arms.

Common features of all CMB range are:

- Die-cast aluminium housing.
- Ground-hardened helical gears.
- Permanent synthetic oil long-life lubrication.
- Input flexible coupling available

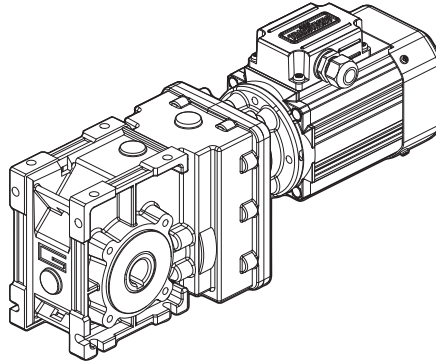

Designazione

Classification

RIDUTTORE / GEARBOX											
CMB	63 3		U	9.81	D25	90	B5	SZDX	BRSX	90	FX
Tipo Type	Grandezza Size	Stadi Stages	Versione Version	Rapporto Ratio	Albero cavo uscita Hollow output shaft	IEC 	Forma costruttiva Version	Albero di uscita Output shaft	Braccio di reazione Torque arm	Angolo Angle	Giunto elastico Flexible coupling
	40 50 63 90	2 3	U FD FS FBD FBS FLD FLS	vedi tabelle see tables	vedi tabelle see tables	56.. — 90..	B5 B14	SZDX SZSX DZ	BRDX BRSX *	0° 90° 180° 270°	FX

RIDUTTORE / GEARBOX									
CMBIS	63 3		U	9.81	D25	SZDX	BRSX	90	
Tipo Type	Grandezza Size	Stadi Stages	Versione Version	Rapporto Ratio	Albero cavo uscita Hollow output shaft	Albero di uscita Output shaft	Braccio di reazione Torque arm	Angolo Angle	
	40 50 63 90	2 3	U FD FS FBD FBS FLD FLS	vedi tabelle see tables	vedi tabelle see tables	SZDX SZSX DZ	BRDX BRSX *	0° 90° 180° 270°	

Versione Riduttore
Gearbox Version

Albero di uscita
Output shaft

Braccio di reazione
Torque arm *

Angolo
Angle

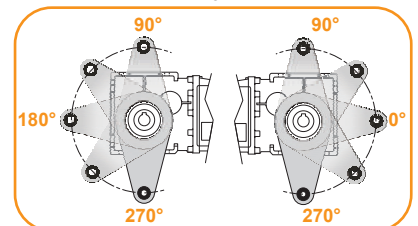
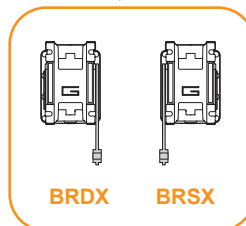
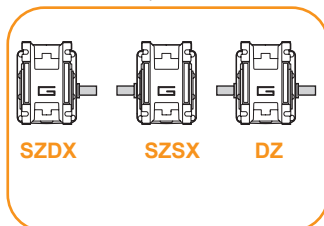
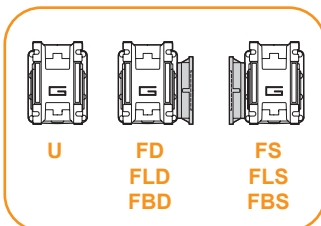

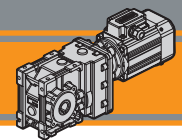

* NOTA: il braccio di reazione viene fornito smontato.
NOTE: the torque arm will be supplied not assembled.



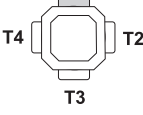

Designazione

Classification

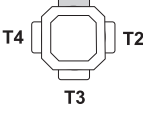
MOTORE TRIFASE / THREE PHASE MOTOR										
SMT	63	2	4	0.18 kW	B14	230-400 V	50 Hz	TEFC	BR	T1
Tipo Type	Grandezza Size	Indicativo potenza Power coefficient	Poli Poles	Potenza Power	Forma costruttiva Version	Tensione Voltage	Frequenza Frequency	Ventilazione Fan cooling	Opzioni Options	Pos. Morsettiera Terminal box pos.
SMT		1-2-3-4-5	4	0.04 kW ... 2.2 kW	B14	230-400 V 460V	50Hz 60Hz	TEFC TENV		T1 (Std)  T4 T2 T3

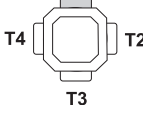

CMB

MOTORE MONOFASE / SINGLE PHASE MOTOR										
SMM	63	2	4	0.18 kW	B14	230 V	50 Hz	TEFC	UL-CSA	T1
Tipo Type	Grandezza Size	Indicativo potenza Power coefficient	Poli Poles	Potenza Power	Forma costruttiva Version	Tensione Voltage	Frequenza Frequency	Ventilazione Fan cooling	Opzioni Options	Pos. Morsettiera Terminal box pos.
SMM		1-2-3-4	4	0.04 kW ... 0.75 kW	B14	230V	50Hz	TEFC TENV		T1 (Std)  T4 T2 T3

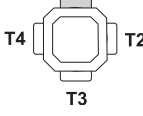

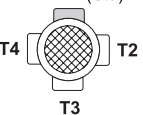
MOTORE TRIFASE / THREE PHASE MOTOR										
TS	63	2	4	0.18 kW	B5	3 ph	230-400 V	50 Hz	T1	
Tipo Type	Grandezza Size	Indicativo potenza Power coefficient	Poli Poles	Potenza Power	Forma costruttiva Version	Fasi Phases	Tensione Voltage	Frequenza Frequency	Pos. Morsettiera Terminal box pos.	
TS		1-2-3-S L1-L2	4	0.09 kW ... 2.2 kW	B5 B14	3 ph	230-400 V 275-480 V	50Hz 60Hz	T1 (Std)  T4 T2 T3	

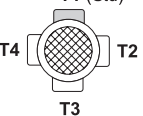

Sensi di rotazione

Direction of rotation

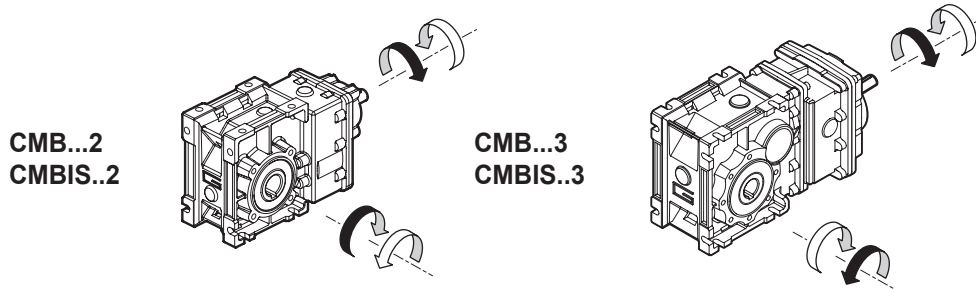

Simbologia

Symbols

n_1	[min^{-1}]	Velocità in ingresso / Input speed
n_2	[min^{-1}]	Velocità in uscita / Output speed
i		Rapporto di riduzione / Ratio
P_1	[kW]	Potenza in entrata / Input power
M_2	[Nm]	Coppia nominale in uscita in funzione di P_1 / Output torque referred to P_1
P_{n1}	[kW]	Potenza nominale in entrata / Nominal input power
M_{n2}	[Nm]	Coppia nominale in uscita in funzione di P_{n1} / Nominal output torque referred to P_{n1}
sf		Fattore di servizio / Service factor
R_2	[N]	Carico radiale ammissibile in uscita / Permitted output radial load
A_2	[N]	Carico assiale ammissibile in uscita / Permitted output axial load
	[kg]	Peso del solo riduttore / Weight of the gearbox only

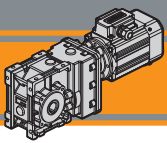

Lubrificazione

Tutti i motoriduttori CMB sono forniti completi di lubrificante sintetico viscosità 320, pertanto possono essere installati in qualunque posizione di montaggio e non necessitano di manutenzione.

Lubrication

Permanent synthetic oil long-life lubrication (viscosity grade 320) makes it possible to use CMB gearmotors in all mounting positions; for this reason they can be installed in any assembly position and do not require maintenance.

Carichi radiali

Radial loads

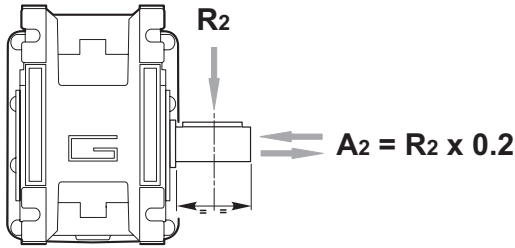

n ₂ [min ⁻¹]	R ₂ [N]			
	CMB 402	CMB 502	CMB 633	CMB 903
400	905	1116	1835	2682
300	996	1228	2020	2952
200	1141	1406	2312	3379
170	1204	1484	2441	3567
140	1414	1743	2604	3806
100	1582	1949	2913	4686
90	1638	2019	3321	4853
60	2047	2490	3801	5556
40	2524	3029	4492	6614
30	2778	3334	5159	7540
20	3180	3816	5906	8631
15	3500	4200	6500	9500
10	3500	4200	6500	9500

Quando il carico radiale risultante non è applicato sulla mezzeria dell'albero occorre calcolare quello effettivo con la seguente formula

When the resulting radial load is not applied on the centre line of the shaft it is necessary to calculate the effective load with the following formula:

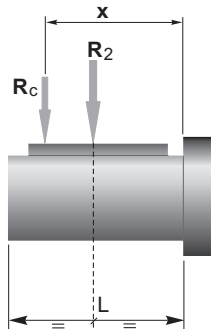

	CMB 402	CMB 502	CMB 633	CMB 903
a	86	104	118	157
b	66	79	93	117
R _{2MAX}	3500	4200	6500	9500

$$R_c = \frac{R_2 \cdot a}{(b + x)} \leq R_{2MAX}$$

$$R \leq R_c$$

a, b = valori riportati nella tabella
a, b = values given in the table

Motori applicabili

Motors adapters

CMB	SMT						SMM					TS					N		
	5014	5624	6324	7124	8024	9024	5014	5624	6324	7124	8024	5624	6314	7114	8024	90S4	100L14	100LB4	112M4
	5024	5634	6334	7134	8034	9034	5024	5634	6334	7134			6324	7124	8034	90L14			
	5034	5444	6344	7144			5034	5444					6334	7134	7144	90L24			
	5044	5654																	
402																			
502																			
633																			
903																			

N.B. Le aree evidenziate in grigio indicano l'applicabilità della corrispondente grandezza motore.

N.B. Grey areas indicate motor inputs available on each size of unit.

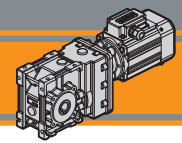

Dati tecnici

n_1 1400 min⁻¹

Technical data

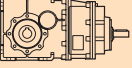
	n_2 [min ⁻¹]	Mn_2 [Nm]	Pn_1 [kW]	i	IEC Motori applicabili IEC Motor adapters			
					56 B5/B14	63 B5/B14	71 B5/B14	80 B5/B14
CMBIS 402								
	227	40	1.0	6.18				*
	187	40	0.83	7.49				*
	152	40	0.68	9.2				*
	118	45	0.59	11.83				*
	112	45	0.56	12.48				*
	94.4	45	0.47	14.83				*
	79.4	45	0.40	17.63				*
	75.3	55	0.46	18.6				*
	62.7	55	0.38	22.33				*
	58.6	55	0.36	23.91				*
	48.5	65	0.35	28.89				*
	45.4	65	0.33	30.84				*
	41.7	65	0.30	33.57				*
	39.3	65	0.28	35.63				*
	32.7	65	0.24	42.75				*
	25.3	65	0.18	55.31				*
	23.7	65	0.17	59.06			*	*
	21.8	65	0.16	64.29			*	*
	19.3	65	0.14	72.50			*	*

	n_2 [min ⁻¹]	Mn_2 [Nm]	Pn_1 [kW]	i	IEC Motori applicabili IEC Motor adapters			
					56 B5/B14	63 B5/B14	71 B5/B14	80 B5/B14
CMBIS 502								
	227	70	1.8	6.18				
	187	70	1.5	7.49				
	152	70	1.2	9.20				
	118	90	1.2	11.83				
	112	90	1.1	12.48				
	94.4	90	0.95	14.83				
	79.4	90	0.80	17.63				
	75.3	110	0.92	18.60				
	62.7	110	0.77	22.33				
	58.6	110	0.72	23.91				
	48.5	125	0.67	28.89				
	45.4	125	0.63	30.84				
	41.7	125	0.58	33.57				
	39.3	125	0.55	35.63				
	32.7	125	0.46	42.75				*
	25.3	125	0.35	55.31				*
	23.7	125	0.33	59.06				*
	21.8	125	0.30	64.29				*
	19.3	125	0.27	72.50				*

N.B.
Le aree evidenziate indicano l'applicabilità della corrispondente grandezza motore.

N.B.
Highlighted areas indicate motor inputs available on each size of unit.

 * = Il fattore di servizio (sf) deve essere scelto in funzione dell'applicazione: si prega di contattare il nostro Servizio Tecnico.

 * = The service factor (sf) has to be selected depending on application: please contact our Technical Department.

Prima di eseguire la scelta del motoriduttore riferirsi alle prestazioni elencate nelle tabelle dalla pag. C8 alla pag. C12.

Before selecting any gearbox, please read the performance values shown in the tables on page C8 to C12.

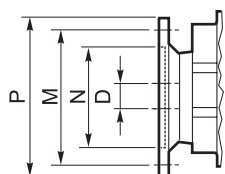

Dimensioni IEC / IEC Dimensions								
	56 B5	56 B14	63 B5	63 B14	71 B5	71 B14	80 B5	80 B14
N	80	50	95	60	110	70	130	80
M	100	65	115	75	130	85	165	100
P	120	80	140	90	160	105	200	120
D	9		11		14		19	

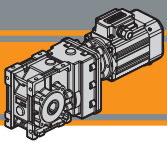

Dati tecnici

n_1 1400 min⁻¹

Technical data

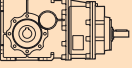
 CMBIS 633	n_2 [min ⁻¹]	Mn_2 [Nm]	Pn_1 [kW]	i	IEC Motori applicabili IEC Motor adapters				
					56 B5/B14	63 B5/B14	71 B5/B14	80 B5/B14	90 B5/B14
213	150	150	3.6	6.58					
175	150	150	2.9	7.99					
143	150	150	2.4	9.81					
134	150	150	2.2	10.44					
112	150	150	1.9	12.53					
105	150	150	1.8	13.31					
88.6	170	170	1.7	15.81					
78.8	220	220	1.9	17.77					
64.9	220	220	1.6	21.56					
52.9	220	220	1.3	26.48					
49.7	220	220	1.2	28.17					
41.4	220	220	1.0	33.81					
39.0	220	220	0.96	35.92					
36.0	250	250	1.00	38.88					
29.7	250	250	0.83	47.16					*
24.2	250	250	0.67	57.93					*
22.7	250	250	0.63	61.63					*
18.9	250	250	0.53	73.96					*
17.8	250	250	0.50	78.58					*
15.0	250	250	0.42	93.33			*		*
10.0	250	250	0.28	140.52			*		*
7.7	250	250	0.21	181.81			*		*
6.6	250	250	0.18	211.31		*	*		*
5.9	250	250	0.16	238.31		*	*		*

N.B.

Le aree evidenziate indicano l'applicabilità della corrispondente grandezza motore.

N.B.

Highlighted areas indicate motor inputs available on each size of unit.



* = Il fattore di servizio (**sf**) deve essere scelto in funzione dell'applicazione: si prega di contattare il nostro Servizio Tecnico.

Prima di eseguire la scelta del motoriduttore riferirsi alle prestazioni elencate nelle tabelle dalla pag. C8 alla pag. C12.



* = The service factor (**sf**) has to be selected depending on application: please contact our Technical Department.

Before selecting any gearbox, please read the performance values shown in the tables on page C8 to C12.

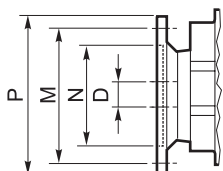

Dimensioni IEC / IEC Dimensions										
	56 B5	56 B14	63 B5	63 B14	71 B5	71 B14	80 B5	80 B14	90 B5	90 B14
N	80	50	95	60	110	70	130	80	130	95
M	100	65	115	75	130	85	165	100	165	115
P	120	80	140	90	160	105	200	120	200	140
D	9		11		14		19		24	

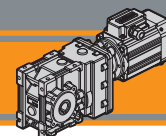

Dati tecnici

n_1 1400 min⁻¹

Technical data

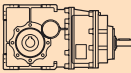
	n_2 [min ⁻¹]	Mn_2 [Nm]	Pn_1 [kW]	i	IEC Motori applicabili IEC Motor adapters			
					71 B5	80 B5/B14	90 B5/B14	100/112 B5/B14
CMBIS 903								
	211	280	6.57	6.65	B			
	175	280	5.46	8.00	B			
	144	280	4.48	9.74	B			
	125	280	3.90	11.21	B			
	99.3	300	3.32	14.09	B			
	78.0	450	3.91	17.95	B			
	64.8	450	3.25	21.60	B			
	53.2	450	2.67	26.30	B			
	46.3	450	2.32	30.25	B			
	35.7	500	1.99	39.26	B			
	29.6	500	1.65	47.25	B			*
	24.3	500	1.36	57.52	B			*
	21.2	500	1.18	66.17	B			*
	16.8	500	0.94	83.20	B			*
	13.0	500	0.72	108.09	B		*	*
	10.6	500	0.59	132.23	B		*	*
	9.5	500	0.53	147.92	B		*	*
	8.4	500	0.47	167.09	B		*	*
	7.3	500	0.41	191.06	B	*	*	*
	6.3	500	0.35	221.88	B	*	*	*
	5.3	500	0.30	262.96	B	*	*	*

CMB

N.B.

Le aree evidenziate indicano l'applicabilità della corrispondente grandezza motore.

B = Boccola di riduzione in acciaio.



* = Il fattore di servizio (**sf**) deve essere scelto in funzione dell'applicazione: si prega di contattare il nostro Servizio Tecnico.

Prima di eseguire la scelta del motoriduttore riferirsi alle prestazioni elencate nelle tabelle dalla pag. C8 alla pag. C12.

N.B.

Highlighted areas indicate motor inputs available on each size of unit.

B = Metal shaft sleeve.



* = The service factor (**sf**) has to be selected depending on application: please contact our Technical Department.

Before selecting any gearbox, please read the performance values shown in the tables on page C8 to C12.

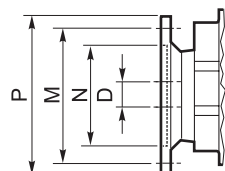



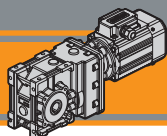

Dimensioni IEC / IEC Dimensions							
	71 B5	80 B5	80 B14	90 B5	90 B14	100/112 B5	100/112 B14
N	110	130	80	130	95	180	110
M	130	165	100	165	115	215	130
P	160	200	120	200	140	250	160
D	14	19		24		28	

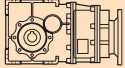
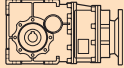

CMB Motoriduttori ad assi ortogonali Helical bevel gearmotors

Dati tecnici

Technical data

P ₁ [kW]	n ₂ [min ⁻¹]	M ₂ [Nm]	sf	i		P ₁ [kW]	n ₂ [min ⁻¹]	M ₂ [Nm]	sf	i	
0.04						0.06					
SMT5014	227	2	25.25	6.18	CMB402	SMT5024	24	23	5.5	59.06	CMB502
SMM5014	187	2	20.81	7.49		SMM5024	22	25	5.1	64.29	
(1400 min ⁻¹)	152	2	16.94	9.20		(1400 min ⁻¹)	19	28	4.5	72.50	
	118	3	14.83	11.83			19	43	5.9	73.96	CMB633
	112	3	14.05	12.48			18	45	5.5	78.58	
	94	4	11.83	14.83			15	54	4.6	93.33	
	79	5	9.95	17.63			10	81	3.1	140.52	
	75	5	11.53	18.60			7.7	105	2.4	181.81	
	63	6	9.61	22.33			6.6	122	2.1	211.31	
	59	6	8.97	23.91			5.9	138	1.8	238.31	
	48	7	8.77	28.89							
	45	8	8.22	30.84							
	42	9	7.55	33.57							
	39	9	7.11	35.63							
	33	11	5.93	42.75							
	25	14	4.58	55.31							
	24	15	4.29	59.06							
	22	16	3.94	64.29							
	19	19	3.50	72.50							
	24	15	8.25	59.06	CMB502						
	22	16	7.58	64.29							
	19	19	6.72	72.50							
	17.8	20	12.40	78.58	CMB633						
	15.0	24	10.44	93.33							
	10.0	36	6.94	140.52							
	7.7	47	5.36	181.81							
	6.6	54	4.61	211.31							
	5.9	61	4.09	238.31							
0.06						0.09					
SMT5024	227	2	16.8	6.18	CMB402	SMT5034	227	4	11	6.18	CMB402
SMM5024	187	3	13.9	7.49		SMM5034	187	4	9.3	7.49	
(1400 min ⁻¹)	152	4	11.3	9.20		SMT5624	152	5	7.5	9.20	
	118	5	9.9	11.83		SMM5624	118	7	6.6	11.83	
	112	5	9.4	12.48		(1400 min ⁻¹)	112	7	6.3	12.48	
	94	6	7.9	14.83			94	9	5.3	14.83	
	79	7	6.6	17.63			79	10	4.4	17.63	
	75	7	7.7	18.60		TS5624	75	11	5.1	18.60	
	63	9	6.4	22.33		(1400 min ⁻¹)	63	13	4.3	22.33	
	59	9	6.0	23.91			59	14	4.0	23.91	
	48	11	5.8	28.89			48	17	3.9	28.89	
	45	12	5.5	30.84			45	18	3.7	30.84	
	42	13	5.0	33.57			42	19	3.4	33.57	
	39	14	4.7	35.63			39	21	3.2	35.63	
	33	16	4.0	42.75			33	25	2.6	42.75	
	25	21	3.1	55.31			25	32	2.0	55.31	
	24	23	2.9	59.06			24	34	1.9	59.06	
	22	25	2.6	64.29			22	37	1.8	64.29	
	19	28	2.3	72.50			19	42	1.6	72.50	
						33	25	5.1	42.75	CMB502	
						25	32	3.9	55.31		
						24	34	3.7	59.06		
						22	37	3.4	64.29		
						19	42	3.0	72.50		
						19	43	5.9	73.96	CMB633	
						18	45	5.5	78.58		
						15	54	4.6	93.33		
						10	81	3.1	140.52		
						7.7	105	2.4	181.81		
						6.6	122	2.1	211.31		
						5.9	138	1.8	238.31		





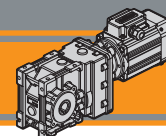

Motori Motors	SMT		SMM		TS
	5014 5024 5034	5624	5014 5024 5034	5624	5624
IEC	56 B14	56 B14	56 B14	56 B14	56 B5 / B14

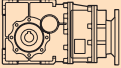
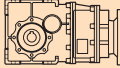

Dati tecnici

Technical data

P ₁ [kW]	n ₂ [min ⁻¹]	M ₂ [Nm]	sf	i		P ₁ [kW]	n ₂ [min ⁻¹]	M ₂ [Nm]	sf	i	
0.12						0.18					
SMT5044	227	5	8.4	6.18	CMB402	SMT5644	45	36	3.5	30.84	CMB502
SMT5634	187	6	6.9	7.49		SMT6324	42	39	3.2	33.57	
SMM5634	152	7	5.6	9.20		SMM5644	39	41	3.0	35.63	
(1400 min ⁻¹)	118	9	4.9	11.83		SMM6324	33	49	2.5	42.75	
	112	10	4.7	12.48		(1400 min ⁻¹)	25	64	2.0	55.31	
TS6314	94	11	3.9	14.83			24	68	1.8	59.06	
(1400 min ⁻¹)	79	14	3.3	17.63		TS6324	22	74	1.7	64.29	
	75	14	3.8	18.60		(1400 min ⁻¹)	19	84	1.5	72.50	
	63	17	3.2	22.33			24	67	3.7	57.93	
	59	18	3.0	23.91			23	71	3.5	61.63	
	48	22	2.9	28.89			19	85	2.9	73.96	
	45	24	2.7	30.84			18	91	2.8	78.58	
	42	26	2.5	33.57			15	108	2.3	93.33	
	39	27	2.4	35.63			10	162	1.5	140.52	
	33	33	2.0	42.75			7.7	210	1.2	181.81	
	25	43	1.5	55.31			6.6	244	1.0	211.31	
	24	45	1.4	59.06			5.9	275	0.9	238.31	
	22	49	1.3	64.29							
	19	56	1.2	72.50							
	33	33	3.8	42.75	CMB502						
	25	43	2.9	55.31							
	24	45	2.8	59.06							
	22	49	2.5	64.29							
	19	56	2.2	72.50							
	19	57	4.4	73.96	CMB633						
	18	60	4.1	78.58							
	15	72	3.5	93.33							
	10	108	2.3	140.52							
	7.7	140	1.8	181.81							
	6.6	163	1.5	211.31							
	5.9	183	1.4	238.31							

0.18					
SMT5644	227	7	5.6	6.18	CMB402
SMT6324	187	9	4.6	7.49	
SMM5644	152	11	3.8	9.20	
SMM6324	118	14	3.3	11.83	
(1400 min ⁻¹)	112	14	3.1	12.48	
	94	17	2.6	14.83	
TS6324	79	20	2.2	17.63	
(1400 min ⁻¹)	75	21	2.6	18.60	
	63	26	2.1	22.33	
	59	28	2.0	23.91	
	48	33	1.9	28.89	
	45	36	1.8	30.84	
	42	39	1.7	33.57	
	39	41	1.6	35.63	
	33	49	1.3	42.75	
	25	64	1.0	55.31	
	24	68	0.95	59.06	
	22	74	0.88	64.29	
	19	84	0.8	72.50	

0.25						
SMT5654	227	10	4.0	6.18	CMB402	
SMT6334	187	12	3.3	7.49		
SMM6334	152	15	2.7	9.20		
(1400 min ⁻¹)	118	19	2.4	11.83		
	112	20	2.2	12.48		
TS6334	94	24	1.9	14.83		
(1400 min ⁻¹)	79	28	1.6	17.63		
	75	30	1.8	18.60		
	63	36	1.5	22.33		
	59	38	1.4	23.91		
	48	46	1.4	28.89		
	45	49	1.3	30.84		
	42	54	1.2	33.57		
	39	57	1.1	35.63		
	33	69	0.9	42.75		
	227	10	7.1	6.18		CMB502
	187	12	5.8	7.49		
	152	15	4.7	9.20		
	118	19	4.7	11.83		
	112	20	4.5	12.48		
	94	24	3.8	14.83		
	79	28	3.2	17.63		
	75	30	3.7	18.60		
	63	36	3.1	22.33		
	59	38	2.9	23.91		
	48	46	2.7	28.89		
	45	49	2.5	30.84		
	42	54	2.3	33.57		
	39	57	2.2	35.63		
	33	69	1.8	42.75		
	25	89	1.4	55.31		
	24	95	1.3	59.06		
	22	103	1.2	64.29		
	19	116	1.1	72.50		



Motori Motors	SMT			SMM		TS	
	5044	5634 5644	6324	5634 5644	6334	6314 6324 6334	7114
IEC	56 B14	56 B14	63 B14	56 B14	63 B14	63 B5 / B14	71 B5 / B14



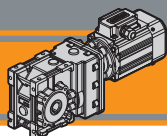





CMB

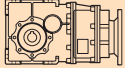
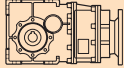

CMB Motoriduttori ad assi ortogonali Helical bevel gearmotors

Dati tecnici

Technical data

P ₁ [kW]	n ₂ [min ⁻¹]	M ₂ [Nm]	sf	i		P ₁ [kW]	n ₂ [min ⁻¹]	M ₂ [Nm]	sf	i	
0.25						0.37					
SMT5654	41	54	4.1	33.81	CMB633	SMT6344	65	51	4.3	21.56	CMB633
SMT6334	39	58	3.8	35.92		SMT7124	53	63	3.5	26.48	
SMM6334	36	62	4.0	38.88		SMM7124	50	67	3.3	28.17	
(1400 min ⁻¹)	30	76	3.3	47.16		(1400 min ⁻¹)	41	80	2.7	33.81	
	24	93	2.7	57.93			39	85	2.6	35.92	
TS6334	23	99	2.5	61.63		TS7124	36	92	2.7	38.88	
TS7114	19	119	2.1	73.96		(1400 min ⁻¹)	30	112	2.2	47.16	
(1400 min ⁻¹)	18	126	2.0	78.58		24	137	1.8	57.93		
	15	150	1.7	93.33		23	146	1.7	61.63		
	10	225	1.1	140.52		19	175	1.4	73.96		
	7.7	291	0.9	181.81	18	186	1.3	78.58			
					15	221	1.1	93.33			
TS7114						TS7124					
	24	92	5.4	57.52	CMB903		30	112	4.5	47.25	CMB903
Solo / Only	21	106	4.7	66.17		Solo / Only	24	136	3.7	57.52	
(1400 min ⁻¹)	17	133	3.7	83.20		(1400 min ⁻¹)	21	157	3.2	66.17	
	13	173	2.9	108.09			17	197	2.5	83.20	
	11	212	2.4	132.23			13	256	1.9	108.09	
	9.5	237	2.1	147.92			11	314	1.6	132.23	
	8.4	268	1.9	167.09			9.5	351	1.4	147.92	
	7.3	306	1.6	191.06			8.4	396	1.3	167.09	
	6.3	356	1.4	221.88			7.3	453	1.1	191.06	
	5.3	422	1.2	262.96			6.3	526	0.9	221.88	
						5.3	624	0.8	262.96		
0.37						0.55					
SMT6344	227	15	2.7	6.18	CMB402	SMT7134	227	22	1.8	6.18	CMB402
SMT7124	187	18	2.3	7.49		SMM7134	187	26	1.5	7.49	
SMM7124	152	22	1.8	9.20		(1400 min ⁻¹)	152	32	1.2	9.20	
(1400 min ⁻¹)	118	28	1.6	11.83			118	42	1.1	11.83	
	112	30	1.5	12.48		TS7134	112	44	1.0	12.48	
TS7124	79	42	1.1	17.63		(1400 min ⁻¹)	94	52	0.9	14.83	
(1400 min ⁻¹)	75	44	1.2	18.60							
	63	53	1.0	22.33							
	59	57	1.0	23.91							
	48	69	0.9	28.89							
	45	73	0.9	30.84							
	42	80	0.8	33.57							
CMB502						CMB502					
227	15	4.8	6.18		CMB502	SMT7134	227	22	3.2	6.18	CMB502
187	18	3.9	7.49			SMM7134	187	26	2.6	7.49	
152	22	3.2	9.20			(1400 min ⁻¹)	152	32	2.2	9.20	
118	28	3.2	11.83				118	42	2.2	11.83	
112	30	3.0	12.48			TS7134	112	44	2.0	12.48	
94	35	2.6	14.83			TS8014	94	52	1.7	14.83	
79	42	2.2	17.63			(1400 min ⁻¹)	79	62	1.4	17.63	
75	44	2.5	18.60				75	66	1.7	18.60	
63	53	2.1	22.33				63	79	1.4	22.33	
59	57	1.9	23.91				59	84	1.3	23.91	
48	69	1.8	28.89			48	102	1.2	28.89		
45	73	1.7	30.84			45	109	1.1	30.84		
42	80	1.6	33.57			42	118	1.1	33.57		
39	85	1.5	35.63			39	126	1.0	35.63		
33	101	1.2	42.75								
25	131	1.0	55.31								
24	140	0.9	59.06								





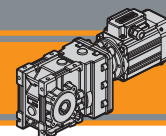



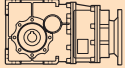
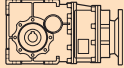

Motori Motors	SMT			SMM		TS	
	5654	6334 6344	7124 7134	6334	7124 7134	7114 7124 7134	8014
IEC	56 B14	63 B14	71 B14	63 B14	71 B14	71 B5 / B14	80 B5 / B14



Dati tecnici

Technical data

P_1 [kW]	n_2 [min ⁻¹]	M_2 [Nm]	sf	i		P_1 [kW]	n_2 [min ⁻¹]	M_2 [Nm]	sf	i	
0.55						0.75					
SMT7134	213	23	6.5	6.58	CMB633	SMT7144	213	32	4.7	6.58	CMB633
SMM7134	175	28	5.3	7.99		SMT8024 IE3	175	38	3.9	7.99	
(1400 min ⁻¹)	143	35	4.3	9.81		SMM8024	143	47	3.2	9.81	
	134	37	4.1	10.44		(1400 min ⁻¹)	134	50	3.0	10.44	
	112	44	3.4	12.53			112	60	2.5	12.53	
TS7134	105	47	3.2	13.31			105	64	2.3	13.31	
TS8014	89	56	3.0	15.81		TS7144	79	85	2.6	17.77	
(1400 min ⁻¹)	79	63	3.5	17.77		TS8024	65	104	2.1	21.56	
	65	76	2.9	21.56		(1400 min ⁻¹)	53	127	1.7	26.48	
	53	93	2.4	26.48			50	135	1.6	28.17	
	50	99	2.2	28.17			41	163	1.4	33.81	
	41	119	1.8	33.81			39	173	1.3	35.92	
	39	127	1.7	35.92			36	187	1.3	38.88	
	36	137	1.8	38.88			30	227	1.1	47.16	
	30	166	1.5	47.16			24	279	0.9	57.93	
	24	204	1.2	57.93			23	296	0.8	61.63	
	23	217	1.2	61.63							
	19	261	1.0	73.96							
	18	277	0.9	78.58							
TS7134						SMT8024 IE3					
	46	107	4.2	30.25	CMB903	SMM8024	53	126	3.6	26.30	CMB903
TS8014	36	138	3.6	39.26		(1400 min ⁻¹)	46	145	3.1	30.25	
Solo / Only	30	167	3.0	47.25			36	189	2.6	39.26	
(1400 min ⁻¹)	24	203	2.5	57.52			30	227	2.2	47.25	
	21	233	2.1	66.17			24	277	1.8	57.52	
	17	293	1.7	83.20			21	318	1.6	66.17	
	13	381	1.3	108.09		TS7144	17	400	1.2	83.20	
	11	466	1.1	132.23			13	520	1.0	108.09	
	9.5	522	1.0	147.92		TS8024					
	8.4	589	0.8	167.09		(1400 min ⁻¹)					
0.75						1.1					
SMT7144	227	30	2.4	6.18	CMB502	SMT8034 IE3	213	46	3.2	6.58	CMB633
SMT8024 IE3	187	36	1.9	7.49		(1400 min ⁻¹)	175	56	2.7	7.99	
SMM8024	152	44	1.6	9.20			143	69	2.2	9.81	
(1400 min ⁻¹)	118	57	1.6	11.83			134	74	2.0	10.44	
	112	60	1.5	12.48			112	88	1.7	12.53	
	94	71	1.3	14.83			105	94	1.6	13.31	
TS7144	79	85	1.1	17.63		TS8034	89	112	1.5	15.81	
TS8024	75	89	1.2	18.60		TS90S4	79	125	1.8	17.77	
(1400 min ⁻¹)	63	107	1.0	22.33		(1400 min ⁻¹)	65	152	1.4	21.56	
	59	115	1.0	23.91			53	187	1.2	26.48	
	48	139	0.9	28.89			50	199	1.1	28.17	
							41	238	0.9	33.81	
						39	253	0.9	35.92		
						36	274	0.9	38.88		

CMB





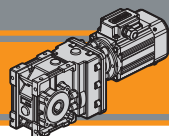

Motori Motors	SMT		SMM		TS		
	7134 7144	8024 8034	7134	8024	7134 7144	8024 8034	90S4
IEC	71 B14	80 B14	71 B14	80 B14	71 B5 / B14	80 B5 / B14	90 B5 / B14

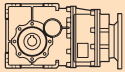
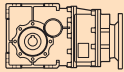

Dati tecnici

Technical data

P ₁ [kW]	n ₂ [min ⁻¹]	M ₂ [Nm]	sf	i		P ₁ [kW]	n ₂ [min ⁻¹]	M ₂ [Nm]	sf	i	
1.1						2.2					
SMT8034 IE3 (1400 min ⁻¹)  TS8034 TS90S4 (1400 min ⁻¹)	211	47	6.0	6.65	CMB903	SMT9034 IE3 (1400 min ⁻¹)  TS90L24 TS100L14 (1400 min ⁻¹)	211	94	3.0	6.65	CMB903
	175	56	5.0	8.00			175	113	2.5	8.00	
	144	69	4.1	9.74			144	137	2.0	9.74	
	125	79	3.5	11.21			125	158	1.8	11.21	
	99	99	3.0	14.09			99	199	1.5	14.09	
	78	127	3.6	17.95			78	253	1.8	17.95	
	65	152	3.0	21.60			65	305	1.5	21.60	
	53	185	2.4	26.30			53	371	1.2	26.30	
	46	213	2.1	30.25			46	427	1.1	30.25	
	36	277	1.8	39.26			36	554	0.9	39.26	
30	333	1.5	47.25								
24	406	1.2	57.52								
21	467	1.1	66.17								
17	587	0.9	83.20								
1.5						3					
SMT9024 IE3 (1400 min ⁻¹)  TS90L14 (1400 min ⁻¹)	213	63	2.4	6.58	CMB633	N100LB4 (1400 min ⁻¹)	211	128	2.2	6.65	CMB903
	175	77	2.0	7.99			175	154	1.8	8.00	
	143	94	1.6	9.81			144	187	1.5	9.74	
	134	100	1.5	10.44			125	216	1.3	11.21	
	112	120	1.2	12.53			99	271	1.1	14.09	
	105	128	1.2	13.31			78	345	1.3	17.95	
	89	152	1.1	15.81			65	416	1.1	21.60	
	79	171	1.3	17.77			53	506	0.9	26.30	
	65	207	1.1	21.56							
	53	255	0.9	26.48							
211	64	4.4	6.65	CMB903							
175	77	3.6	8.00								
144	94	3.0	9.74								
125	108	2.6	11.21								
99	136	2.2	14.09								
78	173	2.6	17.95								
65	208	2.2	21.60								
53	253	1.8	26.30								
46	291	1.5	30.25								
36	378	1.3	39.26								
30	454	1.1	47.25								
24	553	0.9	57.52								
4											
						N112M4 (1400 min ⁻¹)	211	171	1.6	6.65	CMB903
					175		205	1.4	8.00		
					144		250	1.1	9.74		
					125		287	1.0	11.21		
					99		361	0.8	14.09		
					78	460	1.0	17.95			



Motori Motors	SMT		SMM		TS			N	
	8034	9024 9034	7134	8024	8034	90S4 90L14 90L24	100L14	100LB4	112M4
IEC	71 B14	80 B14	71 B14	80 B14	80 B5 / B14	90 B5 / B14	100 B5/B14	100 B5 / B14	112 B5 / B14

Dati tecnici elettrici

Electrical technical data

Si prega di consultare il paragrafo dedicato:

Please see the dedicated paragraph:



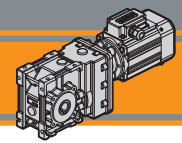

Dimensioni

Dimensions

CMB 402.. - CMBIS 402..

CMB 402 U..

CMBIS 402 U..

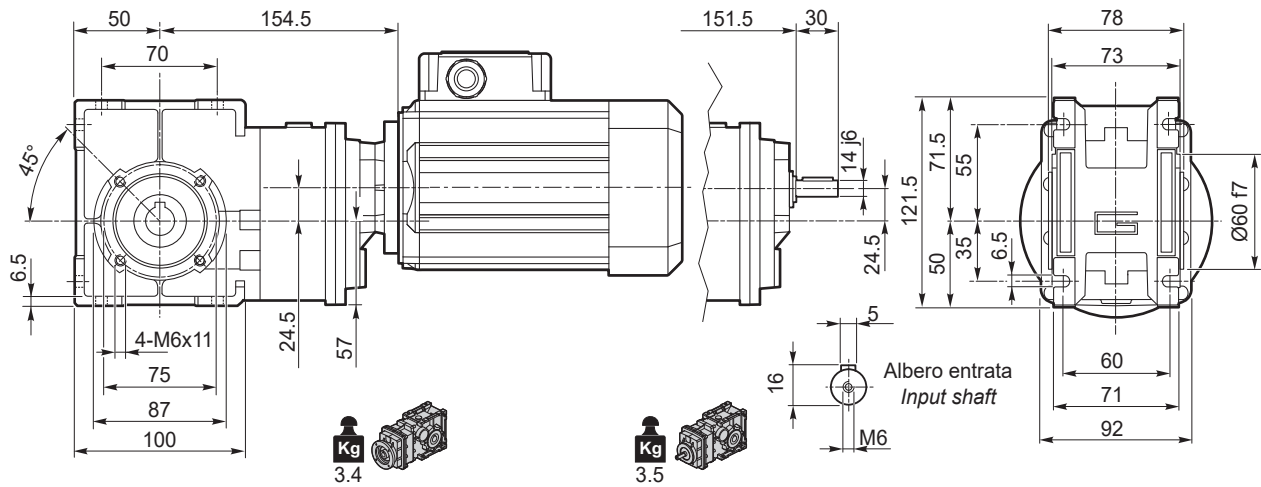

CMB 402 F..

CMBIS 402 F..

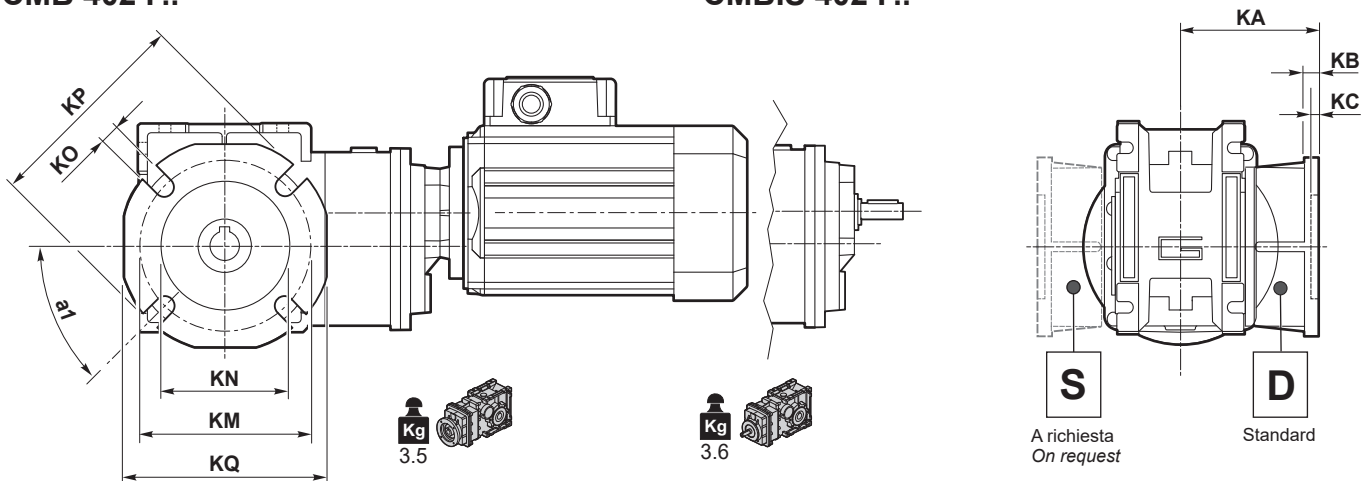

Versione F / F Version										
CMB CMBIS	a ₁	KA	KB	KC	KM	KN H8	KO	KP	KQ	Flangia / Flange Tipo / Type
402	45°	67	7.5	4.5	80-95	60	9	110	95	F
	45°	97	7.5	4.5	80-95	60	9	110	95	FL
	45°	80	8.5	5	115-125	95	9.5	140	112	FB

CMB 402.. D18 - CMBIS 402.. D18
CMB 402.. D20 - CMBIS 402.. D20

Flangia entrata
Input flange



Albero uscita cavo
Hollow output shaft

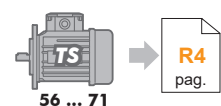
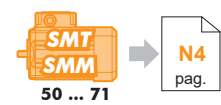
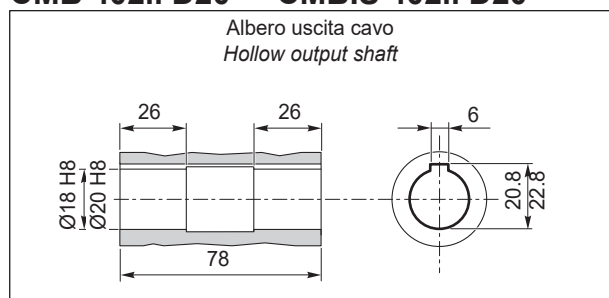

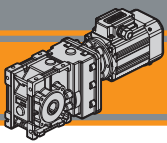

Dimensioni

Dimensions

CMB 502.. - CMBIS 502..

CMB 502 U..

CMBIS 502 U..

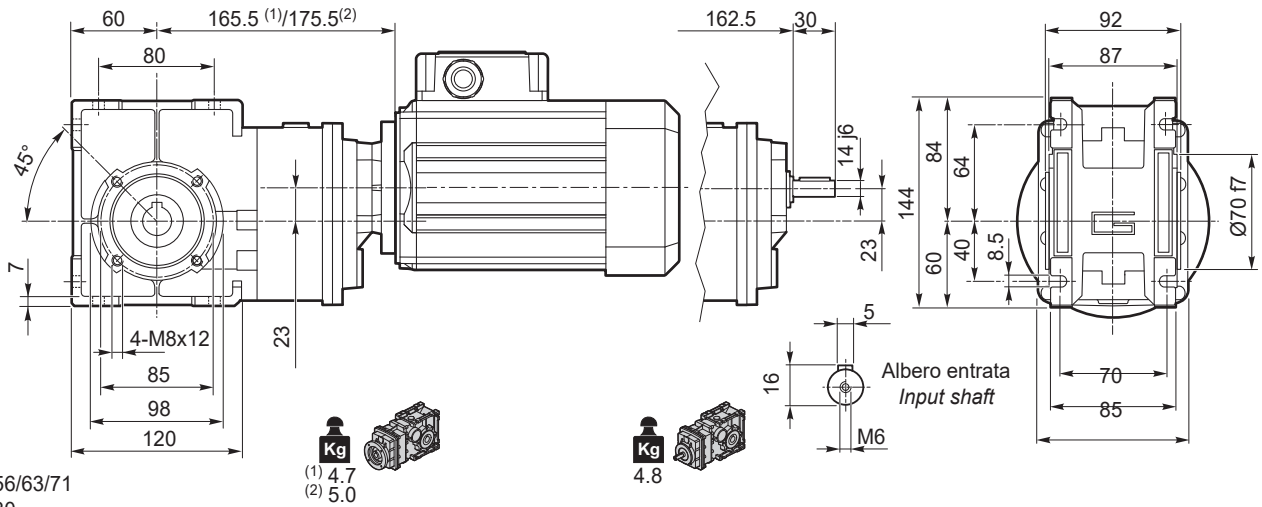

(1) IEC 56/63/71
(2) IEC 80

CMB 502 F..

CMBIS 502 F..

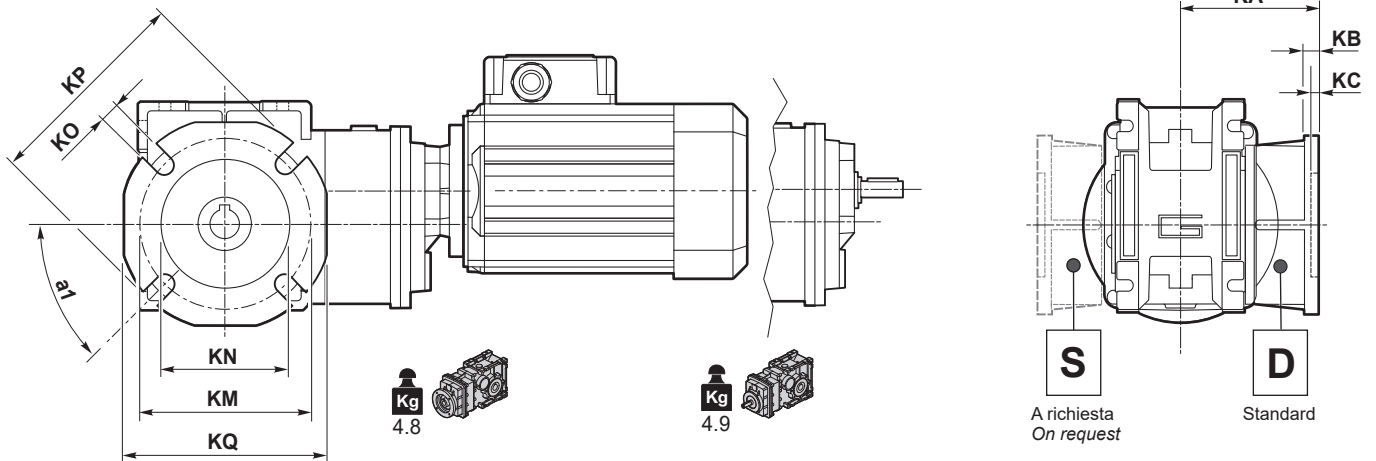

Versione F / F Version										
CMB CMBIS	a ₁	KA	KB	KC	KM	KN H8	KO	KP	KQ	Flangia / Flange Tipo / Type
502	45°	90	9	5	90-110	70	11	125	110	F
	45°	120	9	5	90-110	70	11	125	110	FL
	45°	89	9	5	130-145	110	9.5	160	132	FB

CMB 502.. D25 - CMBIS 502.. D25

Flangia entrata
Input flange



Albero uscita cavo
Hollow output shaft

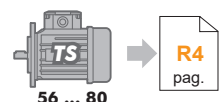
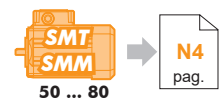
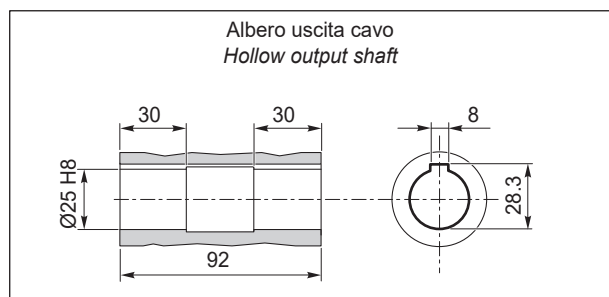

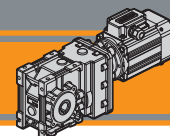

Dimensioni

Dimensions

CMB 633.. - CMBIS 633..

CMB 633 U..

CMBIS 633 U..

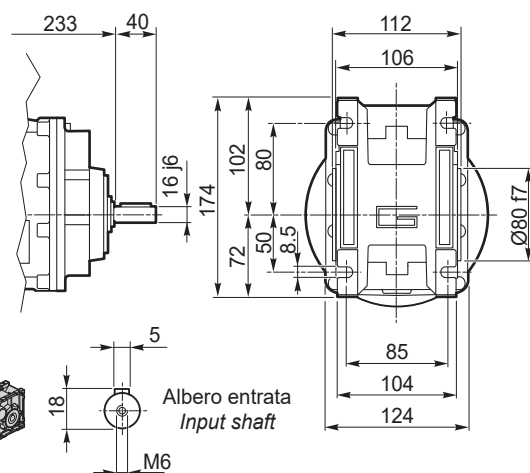
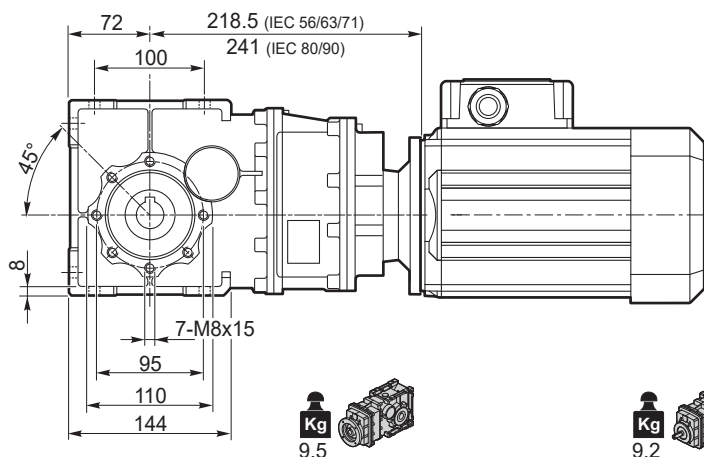

CMB 633 F..

CMBIS 633 F..

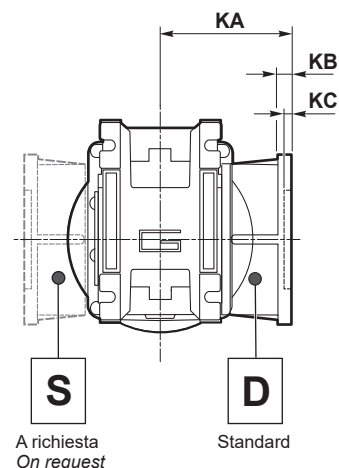
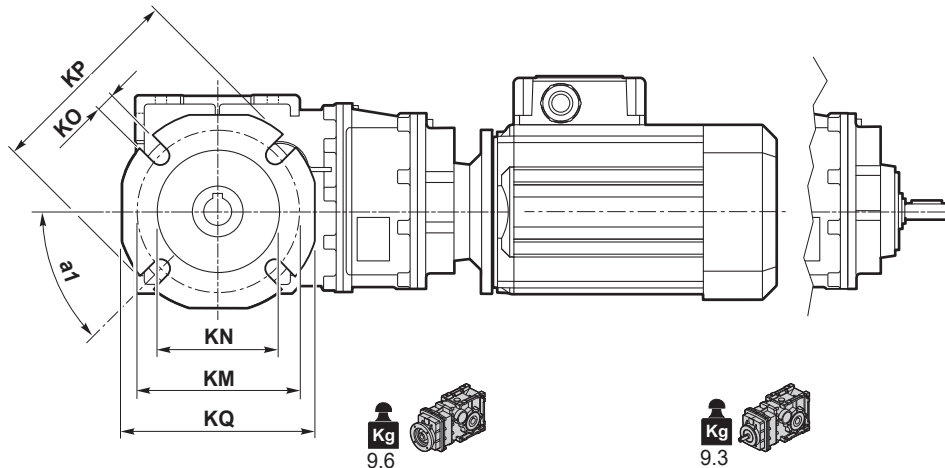

Versione F / F Version										
CMB CMBIS	a ₁	KA	KB	KC	KM	KN H8	KO	KP	KQ	Flangia / Flange Tipo / Type
633	45°	82	10	6	150-160	115	11	180	142	F
	45°	112	10	8	150-160	115	11	180	142	FL
	45°	98	11	5	165	130	11	200	160	FB

CMB 633.. D25
CMBIS 633.. D25

CMB 633.. D30
CMBIS 633.. D30

Flangia entrata
Input flange

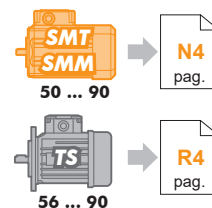
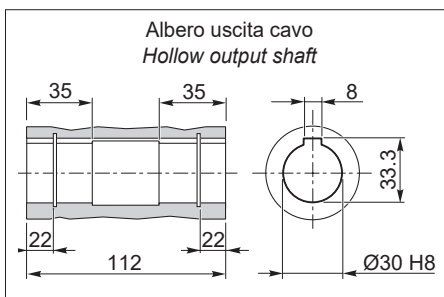
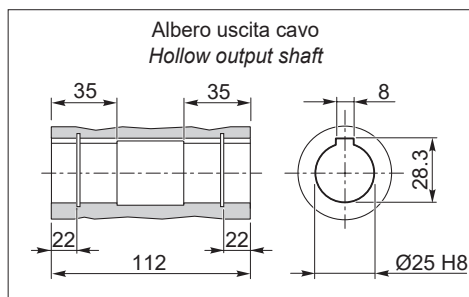

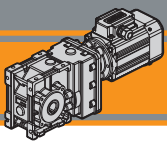

Dimensioni

Dimensions

CMB 903.. - CMBIS 903..

CMB 903 U..

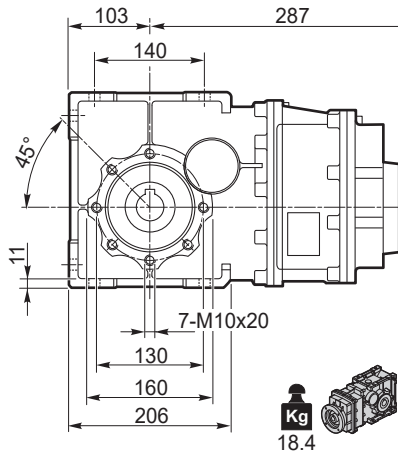

CMBIS 903 U..

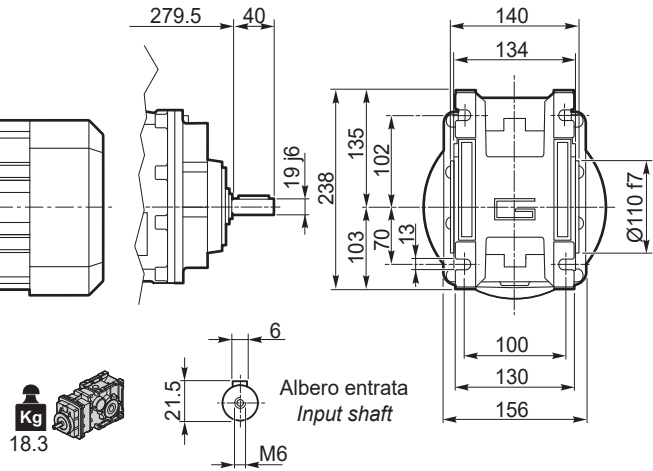

CMB 903 F..

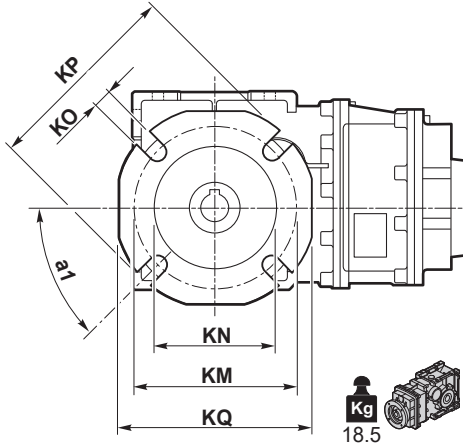

CMBIS 903 F..

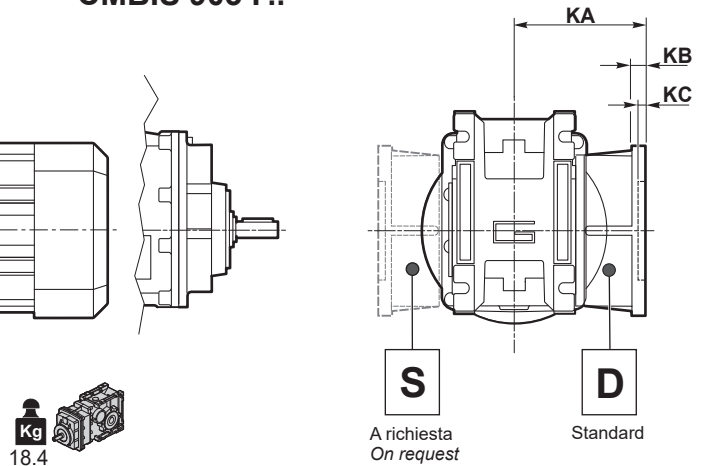

Versione F / F Version

CMB CMBIS	a ₁	KA	KB	KC	KM	KN H8	KO	KP	KQ	Flangia / Flange Tipo / Type
903	45°	111	13	6	175-188	152	14	210	200	F

CMB 903.. D35 - CMBIS 903.. D35

Flangia entrata
Input flange



Albero uscita cavo
Hollow output shaft

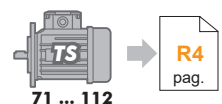
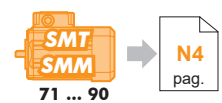
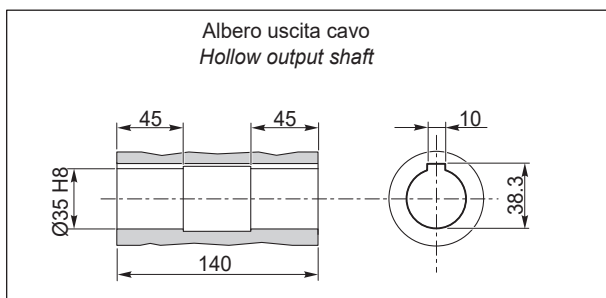

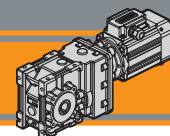

Accessori

Accessories

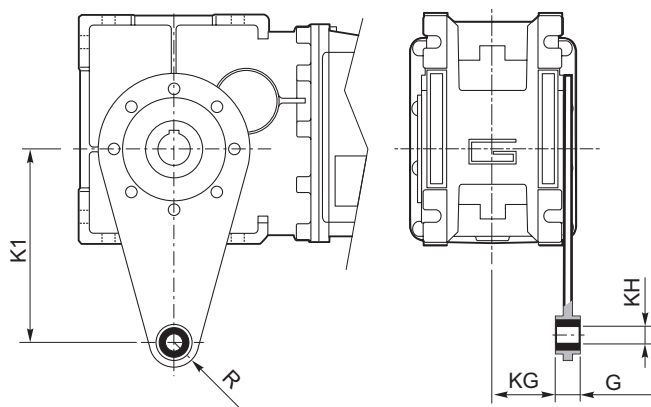
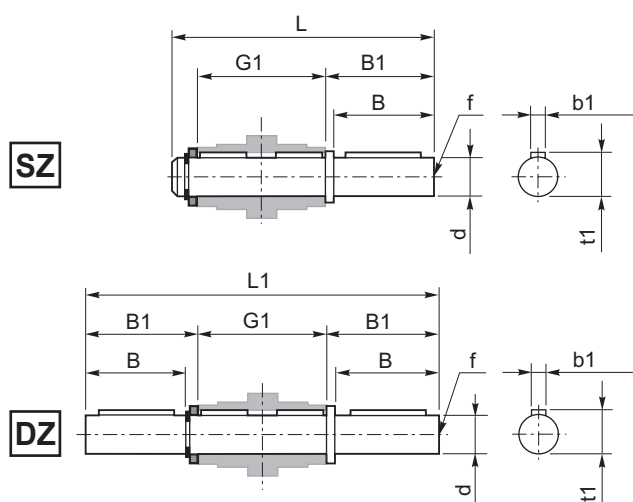

Albero lento / Output shaft

CMB CMBIS	d h7	B	B1	G1	L	L1	f	b1	t1
402	18	40	43	78	128	164	M6	6	20.5
502	25	50	53.5	92	153	199	M10	8	28
633	25	50	53.5	112	173	219	M10	8	28
903	35	80	84.5	140	234	309	M12	10	38

Braccio di reazione / Torque arm

CMB CMBIS	K1	G	KG	KH	R
402	100	14	31	10	18
502	100	14	38	10	18
633	150	14	47.5	10	18
903	200	25	56.5	20	30

SC - Safety cover

WD - Washdown cover

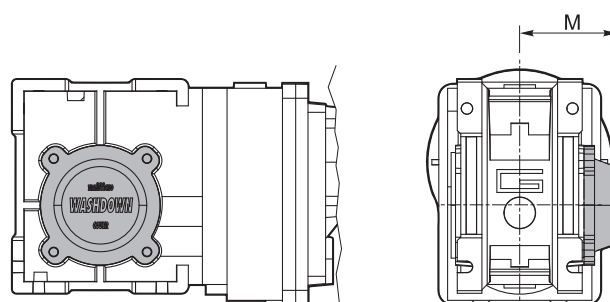
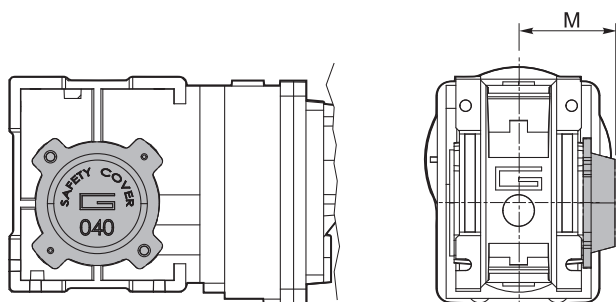

CMB CMBIS	M
402	54.5
502	62.5
633	73
903	94

CMB CMBIS	M
402	55.5
502	63.5
633	71.5
903	95

CMB



TRANSTECNO SRL HEADQUARTERS

Company subject to the management
and coordination of INTERPUMP GROUP SPA
Via Caduti di Sabbiano, 11/D-E
40011 Anzola dell'Emilia (BO)
ITALY
T+39 051 64 25 811
F +39 051 73 49 43
sales@transtecno.com
www.transtecno.com



HANGZHOU TRANSTECNO POWER TRANSMISSIONS CO LTD
No.4 Xiuyan Road Fengdu Industry Zone
Pingyao Town Yuhang District
Hangzhou City, Zhejiang Province
311115 – CHINA
T +86 571 86 92 02 60
F +86 571 86 92 18 10
info-china@transtecno.cn
www.transtecno.cn



MA TRANSTECNO S.A.P.I. DE C.V.
Av. Mundial # 176, Parque Industrial
JM Apodaca, Nuevo León,
C.P. 66600 – MÉXICO
T +52 8113340920
info@transtecno.com.mx
www.transtecno.com.mx



TRANSTECNO IBÉRICA THE MODULAR GEARMOTOR, S.A.
Carrer de la Ciència, 45
08840 Viladecans (Barcelona) – SPAIN
T +34 931 598 950
info@transtecno.es
www.transtecno.es



TRANSTECNO B.V.
Siliciumweg 32
3812 SX Amersfoort – NETHERLANDS
T +31(0) 33 45 19 505
F +31(0) 33 45 19 506
info@transtecno.nl
www.transtecno.nl

www.transtecno.com



TRANSTECNO AANDRIJFTECHNIEK B.V.
Siliciumweg 32
3812 SX Amersfoort – NETHERLANDS
T +31 (0) 33 20 47 006
info@transtecnoandrijftechnik.nl
www.transtecnoandrijftechnik.nl



TRANSTECNO USA
8 Creek Parkway,
Boothwyn PA 19061-8136 - UNITED STATES
T + 1 (610) 4970154
F +1 (610) 497 6085

TRANSTECNO USA – WEST COAST BRANCH
14561 Fryelands Blvd SE
Monroe, WA 98272 – UNITED STATES
T +1 360-863-1300
F +1 360-863-1303
usaoffice@transtecno.com
www.transtecno.com



TRANSTECNO CANADA
51 B Caldari Road Unit 10
Vaughan, ON L4K 4G3 - CANADA
T +1 905 761 0762
F +1 905 761 9265
canadaoffice@transtecno.com
www.transtecno.com



TRANSTECNO CHILE-PERU
Av. Los Libertadores 41
Parque Industrial - Los Libertadores 16.500
Santiago, Colina - CHILE
T +56 2 29633870

Carretera Panamericana Sur KM 29.5,
Interior I-3, Z.I. Lurin - PERU
T +51 1 3546259 / +51 1 3434231
chileoffice@transtecno.com
www.transtecno.com



TRANSTECNO INDIA
#6A, Sipcot Industrial complex, Phase-1, Elasagiri Road
Hosur – 635126 Tamilnadu - INDIA
T +91 4344 274434
M +91 81443 88800

TRANSTECNO INDIA – NORTH BRANCH
Plot No: 3 A, Sector 2, IIE, Sidcul, Pantnagar
U.S. Nagar, Uttarakhand – 263153 - INDIA
indiaoffice@transtecno.com
www.transtecno.com



SALES OFFICE BRAZIL
Rua Dr. Freire Alemão 155 / 402 - CEP. 90450-060
Auxiliadora Porto Alegre RS - BRAZIL
T +55 51 3251 5447
F +55 51 3251 5447
M +55 51 811 45 962
braziloffice@transtecno.com
www.transtecno.com.br



SALES OFFICE OCEANIA
Unit 5, 12 Nyholt Drive, Yatala 4207
Queensland - AUSTRALIA
T +61 07 3800 0103
M +61 04 38060997
oceaniaoffice@transtecno.com
www.transtecno.com.au



SALES OFFICE SOUTH KOREA
772-41, Bongdong-ro, Bongdong-eup, Wanju-goon
Chonbuk, 55313
SOUTH KOREA
T +82 70 8867 8897
F +82 504 199 2107
M +82 10 5094 2107
koreaoffice@transtecno.com
www.transtecno.com